

PRODUCTS

# Framery O

Ideal for one – awkward for two



**Framery O** is ideal for important calls or video conferences. Have your discussions in privacy without disturbing your colleagues. The classic office phone booth delivers leading sound insulation standards and echo-free acoustics, providing a comfortable working environment for one.

# Perfect for you

How do you work best? Choose the interior layout that best suits your needs.



Framery O Standard

## For quick calls

If you work best on your feet, choose Framery O without a seat. Perfect for those quick ad-hoc calls and standing work. Installation is fast and the pod is ready to be used the same day it's delivered.

### Framery O Standard options

- Frame, exterior and seat colors
- 2 Table options (Regular, Wide)
- Wireless charger (for Wide table)
- Self-closing hinges
- Electromechanical code lock
- LAN cable
- Movability kit



Framery O Video Conference Ready

## Videoconferences are here to stay

Framery O is also available in the Video Conference Ready variant. A tilting screen bracket and the LED lighting surrounding the screen provide optimal conditions for videoconferences, with the control panel enabling you to adjust the lighting and airflow inside the pod.

### Framery O Video Conference Ready options

- Frame, exterior and seat colors
- Wireless charger
- Self-closing hinges
- Electromechanical code lock
- LAN cable
- Movability kit





# Framery O















## COLORS

### Exterior

 White Glossy (Standard) RAL 9016	 Black RAL 9005	 Petrol Blue RAL 690-6	 Purple Red RAL 3004	 Forest Green RAL 750-4
 White Ultramatt & Whiteboard exterior	 Cloudy Gray RAL 850-2	 50's Blue RAL 6034	 Lemon RAL 1012	 Spring Green RAL 230-6
 Gray S7500-N	 Misty Blue RAL 620-3	 Burned Orange RAL 410-5	 Piglet Pink RAL 940-6	 Brushed Stainless Steel
 Blush 2728-R01B	 Winter Moss S 7010-G10Y	 Navy S 7020 - R90B	 Powder Blue 3421-R86B	 Sand S 2010 - Y20R



















### Frame

 White (Standard) F6463 Formica	 Black F2253 Formica	 Cloudy Gray F0189 Formica
 50's Blue F7879 Formica	 Burned Orange F2962 Formica	 Purple Red F7966 Formica
 Forest Green F7967 Formica	 Spring Green 0630-60 Resopal	 Petrol Blue 850 Abet Laminati
 Misty Blue F1998 Formica	 Lemon 0647 Arpa Industriale	 Piglet Pink 830 Abet Laminati

### Table

 White (Standard) White laminate	 Black Black laminate
--	---

### Seat fabrics

 Light Gray (Standard) Remix 3 #123 Kvadrat	 Black Remix 3 #183 Kvadrat	 Cloudy Gray Divina MD #733 Kvadrat	 Green Select #68209 Gabriel	 Petrol Blue Divina MD #843 Kvadrat
 50's Blue Divina MD #813 Kvadrat	 Burned Orange Divina 3 #542 Kvadrat	 Purple Red Divina MD #633 Kvadrat	 Piglet Pink Divina MD #613 Kvadrat	 Forest Green Divina 3 #876 Kvadrat
 Graphite Select #60051 Gabriel	 Dark Blue Select #66144 Gabriel	 Powder Blue Select #67098 Gabriel	 Beige Select #61184 Gabriel	 Mustard Select #62098 Gabriel
 Grape Select #61190 Gabriel	 Rose Select #65117 Gabriel	 Misty Blue Divina Melange 2 #731 Kvadrat	 Antimicrobial Highland Graphite 954 Panaz	

## MATERIALS

### Exterior

Painted sheet metal or brushed stainless steel

### Frames and table

Formica laminate on birch plywood with varnish trim

### Carpet

Anti-static and stain resistant low loop pile carpet for the floor

### Walls and roof

A sandwich element of sheet metal, birch plywood, recycled acoustic foam and acoustic felt

### Glass

Sound control laminated glass (4 + 4 mm)



### Optional movability kit

Includes castors that are installed to the bottom of a pod for moving it.



## MEASUREMENTS

### Exterior

221 cm × 100 cm × 100 cm (height, width, depth)  
7.2 ft × 3.3 ft × 3.3 ft (height, width, depth)

### Interior

200 cm × 80 cm × 95 cm (height, width, depth)  
6.5 ft × 2.6 ft × 3.1 ft (height, width, depth)

### Doorway

84 cm wide / 2.75 ft wide

### Regular table

13 cm × 70 cm × 28,5 cm (height, width, depth)  
5,1 in × 27,5 in × 11,2 in (height, width, depth)  
Table height from floor: 102,5 cm / 3.3 ft

### Wide table

12 cm × 75 cm × 30 cm (height, width, depth)  
4,7 in × 29,5 in × 11,8 in (height, width, depth)  
Table height from floor: 102,5 cm / 3.3 ft

Power cord can be led out of the bottom corner of the pod.  
The cord length outside the pods is 4,5 m / 14.7 ft

### Weight

320 kg / 705 lb

### Ventilation space

(Minimum recommended space for air to circulate)

Sides: 5 cm / 1,9 in

Above: 15 cm / 5,9 in

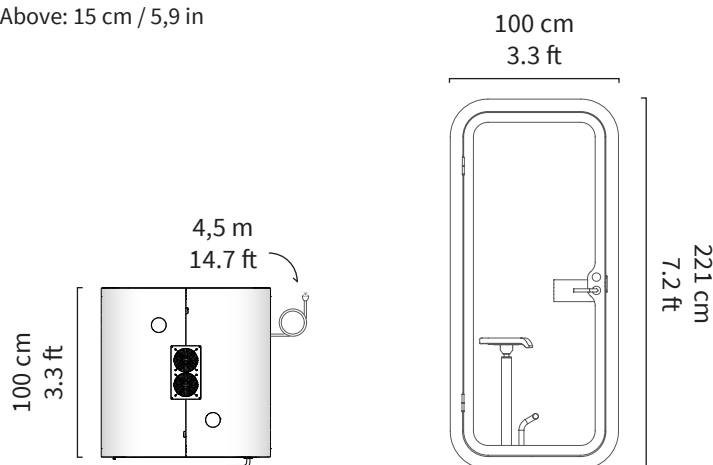

## POWER FRAMERY O

### Power consumption

13 W while in use (Standard configuration)  
- LED light: 10 W  
- Fans in total: 3,1 W  
0,8 W in standby mode  
Input: 100–240 VAC, 8.0 A, 50–60 Hz

### Regular table outlets

Power socket  
Optional: LAN

### Wide table outlets

Power socket, USB-A+C  
Optional: LAN

### Output values

Output VAC (power socket): 100–240 VAC, 6,6 A, 50–60 Hz  
Output USB (TUF) charging:  
Maximum combined output of 5 A at 5 VDC (25 W)

## POWER FRAMERY O VIDEO CONFERENCE READY

### Power consumption

28 W while in use (Standard configuration)  
- LED wall light: 10 W  
- LED wall light: 12,5 W  
- Fans in total: 3,1 W  
- 0,8 W in standby mode  
Input: 100–240 VAC, 8.0 A, 50–60 Hz

### Wide table outlets

Power socket, USB-A+C  
Optional: LAN

### Output values

Output VAC (power socket): 100–240 VAC, 6,6 A, 50–60 Hz  
Output USB (TUF) charging:  
Maximum combined output of 5 A at 5 VDC (25 W)

All electric components can be changed if there is a malfunction. Power consumption is a constant value that is determined by the power usage of the pods' internal components (electric unit, motion detector, light and fans). Framery's products can be plugged into a wall socket. The pods have their own power supplies that give 24 VDC to the lights and 12 VDC to the fans. The lights and fans are operated by a motion detector. Inside the pods, there are country-specific power outlets for charging mobile devices.

## OTHER

### Ventilation

Total airflow is 21,5 l/s, 45 CFM (77,4 m<sup>3</sup>/h)  
On standby mode the fans are working on 25 % of the maximum power.

### Acoustics

Speech level reduction (D<sub>S,A</sub>) according to ISO 23351-1 testing method: 30 dB

### Lighting

LED light: 4000 K and 300 lux

### Screen bracket - Framery O Video Conference Ready

Tilting screen bracket. Maximum display size 24" with flat VESA 100 × 100 mounting surface. Screen not included.

### Control panel - Framery O Video Conference Ready

Adjust ventilation and brightness of ceiling and wall lights